

7-16 ATTENUATOR

6 DB 2 GHZ 100W

R420.706.118

Series : ATTENUATOR

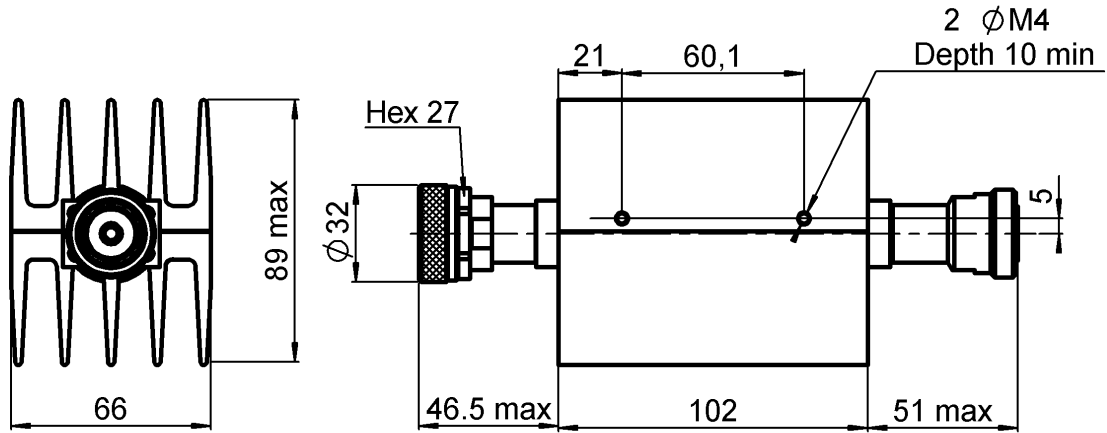

All dimensions are in mm.

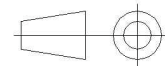

COMPONENTS	MATERIALS	PLATING(μm)
BODY	BRASS	BBR 0.5 OVER SILVER 3
MALE CENTER CONTACT	BRASS	BBR 0.5 OVER SILVER 3
FEMALE CENTER CONTACT	BERYLLIUM COPPER	BBR 0.5 OVER SILVER 3
OUTER CONTACT	BRASS	BBR 0.5 OVER SILVER 5
INSULATOR	PTFE	
GASKET	SILICONE RUBBER	
SUBSTRATE	ALUMINA	
RESISTOR	THICK FILM	
OTHERS PARTS	ALUMINIUM	BLACK PAINTING

Issue : 0542 D

In the effort to improve our products, we reserve the right to make changes judged to be necessary.

7-16 ATTENUATOR

R420.706.118

6 DB 2 GHZ 100W

Series : ATTENUATOR

ELECTRICAL CHARACTERISTICS

Frequency (GHz)	DC - 1	1 - 2
V.S.W.R (≤)	1.10	1.25
Deviation(±dB)	1.0	1.0

Operating Frequency Range	DC - 2	GHz
Impedance	50	Ω
Nominal Attenuation	6	dB
Peak power at 25°C (1μs, 1%)	5000	W
Average power at 25°C	100	W (Free Air Cooled) W (Conduction Cooled)

MECHANICAL CHARACTERISTICS

Connectors	7-16	Male Female	IEC 169-4
Weight	931.411	g	

ENVIRONMENTAL CHARACTERISTICS

Operating temperature range	-40 / +85 °C
Storage temperature range	-40 / +85 °C



SPECIFICATION

OTHER CHARACTERISTICS

Issue : 0542 D

In the effort to improve our products, we reserve the right to make changes judged to be necessary.